

From Eye to Insight



FIND
THE MISSING
LINKS

DMi8 S

Advanced Live Cell
Imaging Solution



DMi8 S – ADVANCED LIVE CELL IMAGING SOLUTION



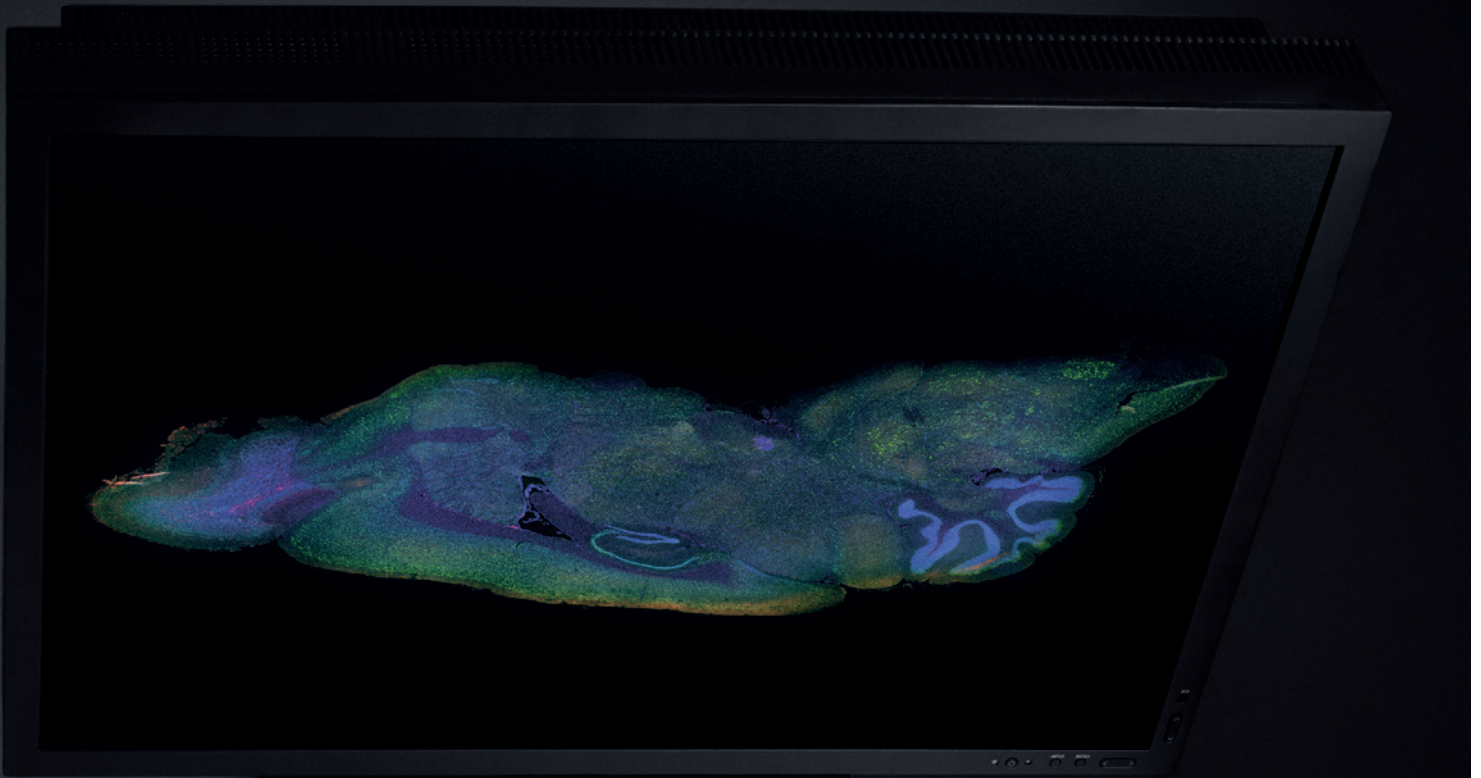

See what you've been missing

The DMi8 S is a complete solution for advanced widefield research. The research process begins with the discovery and analysis of single molecules. From there, piecing together interactions between complexes and signaling pathways leads to the analysis of complete systems – culminating in breakthroughs in understanding and treating human health.

The key to the next scientific discovery lies in finding the missing links connecting your data. Whether you need to precisely follow the development of a single cell in a dish, screen through multiple assays, obtain single molecule resolution, or tease out behaviors of complex processes, the DMi8 S system will enable you to see more, see faster, and find the hidden.



“The DMi8 S is a versatile and user-friendly system that empowers biomedical researchers to probe molecular machineries within the cell with super-resolution, photo-manipulation and optogenetics.”

Dr. Alessandro Esposito, Hutchison MRC Research Centre, University of Cambridge, UK.

The next chapter in widefield imaging

At the heart of the DMi8 S system is the modular DMi8 inverted microscope. Fully configurable with manual to motorized components, it allows you to create the ideal imaging system for your research and budget needs.

Every DMi8 can be equipped with up to two Infinity Ports, allowing direct access into the fluorescent light path for addition of the latest in fluorescence technology, such as the Infinity Scanner or Infinity TIRF. Flexibility is built into the DMi8 microscope, and this is extended even further with the DMi8 S. With added software tools, revolutionary high speed control, and the Infinity modules, the DMi8 S is truly a complete research solution.

See more – Increase your viewing area up to 10,000x

See faster – Image up to 5x faster

See the hidden – Activate, ablate, and bleach within one experiment

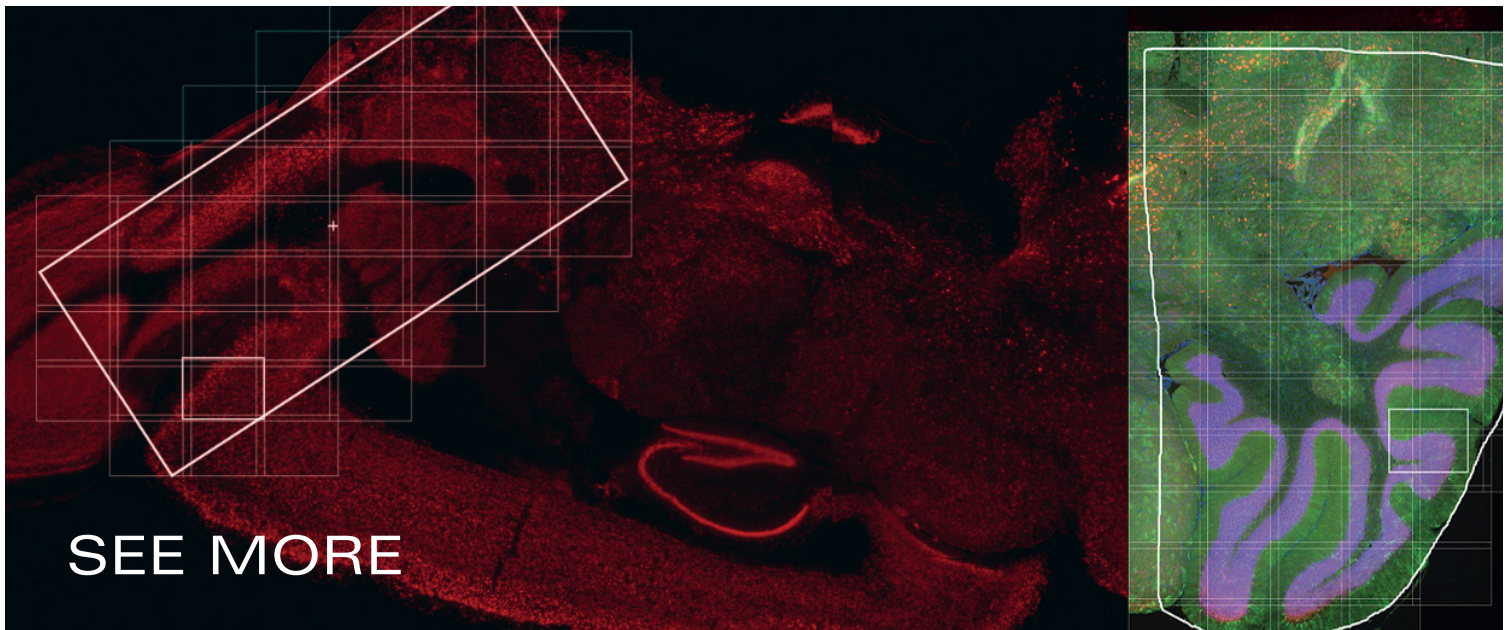

Overview scan of mouse brain section with proliferating cells (BrdU – red), cell nuclei (Dapi – blue), and mature neurons (NeuN – green) stained, with two regions of interest selected for higher resolution tile scans. Courtesy of Dr. Wei Mo, School of Life Sciences, Xiamen University, China.

LAS X NAVIGATOR SOFTWARE

INCREASE YOUR VIEWING AREA UP TO 10,000X

See more of the links you've been missing

Switch from searching image by image to seeing the full overview of your samples. Like a GPS for your cells, LAS X Navigator ensures that you always have a clear roadmap to brilliant data. Create fast overviews of your samples and identify the important details instantly. Then set up high resolution image acquisition automatically using templates for slides, dishes and multiwell plates.

For drug screening assays, use LAS X Navigator to take a fast overview of an entire 96 well plate using a low magnification. Quickly identify the wells with interesting morphology, then set up a high resolution image acquisition of the chosen candidates for deeper analysis, all within the same workspace.

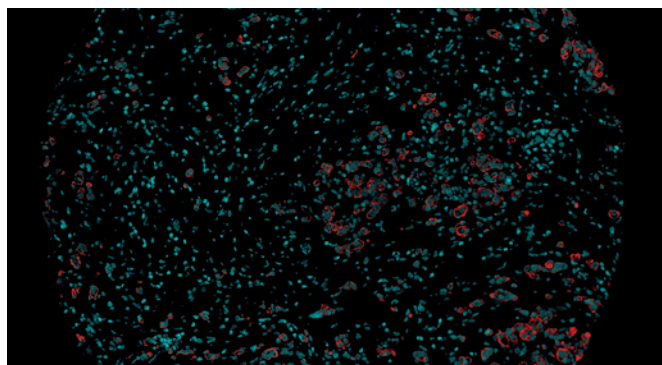

Tile scan image of tissue micro array (TMA) of human tissue stained with two fluorescent markers. Courtesy of Dr. Angela Nieto Toledano, Institute of Neurosciences, Universidad Miguel Hernández (UMH), Spain.

When searching for rare cellular events to image, searching manually often takes a lot of time and causes significant photostress to the cells. LAS X Navigator enables quick overviews of an entire dish, saving valuable time to find the interesting cells to study.

LAS X Software

LAS X Navigator is the latest addition to the Leica Application Suite X (LAS X) software, an integral part of the DMi8 S solution. The software is packed with features for advanced experiments, yet remains as flexible and usable as the microscope itself. Choose from a host of acquisition modules, plus add powerful analysis capabilities to create meaningful and publishable data.



Mouse embryonic sections. Courtesy of Didier Hensch, IGBMC, Strasbourg, France.

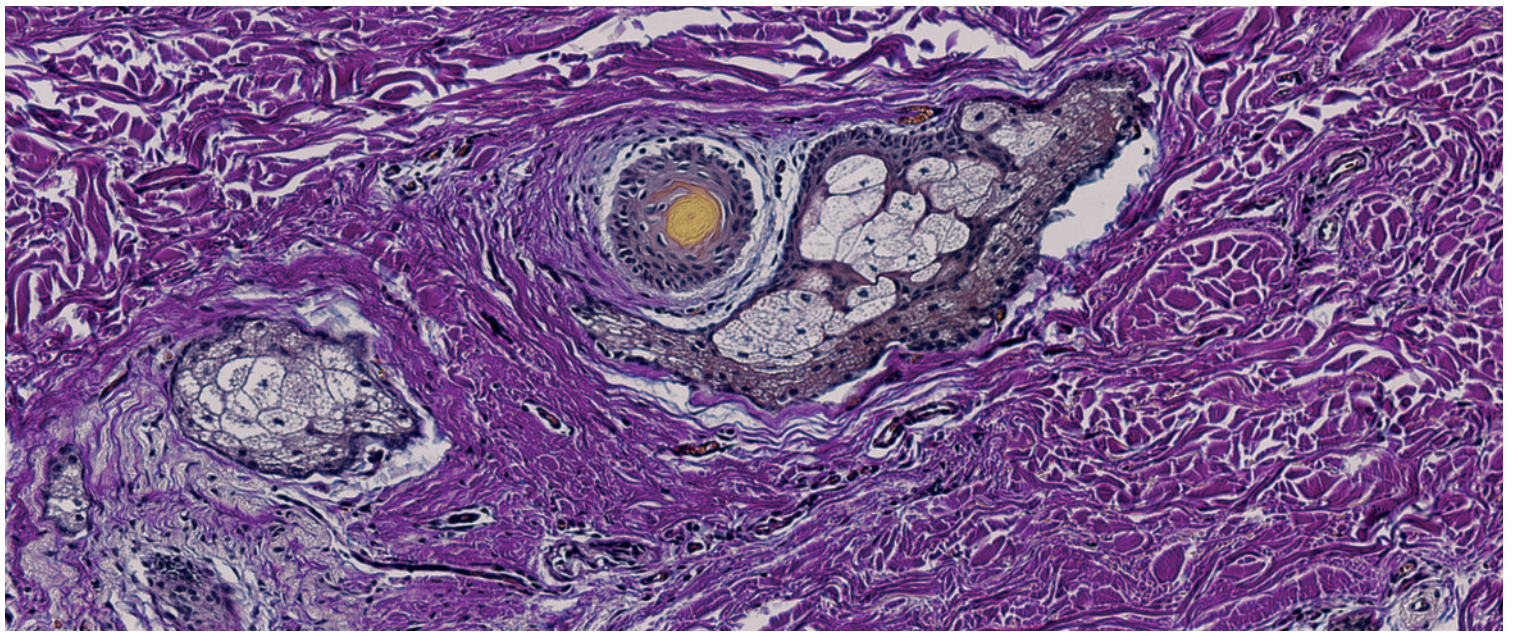

Herovici staining of human skin with scar tissue. Courtesy of Dr. Swathi Balaji, Baylor College of Medicine, Houston, Texas, USA.

Find your answers

No matter what experiments you have in mind, LAS X Navigator is the key to all applications on your DMi8 S imaging system.

- > **Generate overviews from your live image**
- > **Create spiral scans to search in the vicinity of your current location**
- > **Display images in sample carrier templates for quick orientation**
- > **Use any magnification, camera, detector, and contrasting method in the same workspace**
- > **Define an unlimited number of regions and positions for high resolution scans or multiwell projects**
- > **Zoom swiftly in and out of your sample**
- > **Move to any stage location by mouse click**

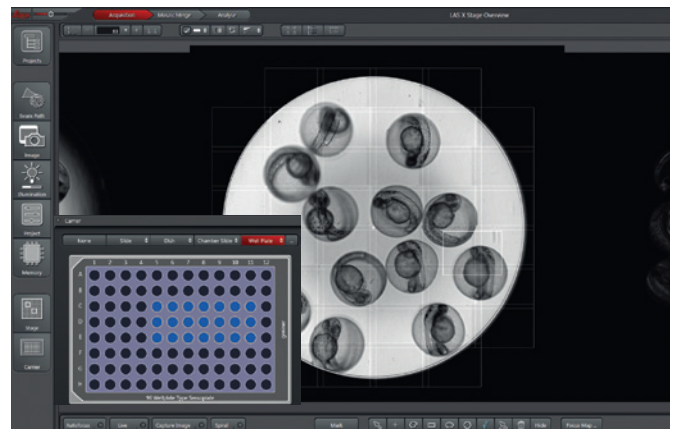

Zebrafish larvae. Courtesy of Ravindra Peravali, Institute of Toxicology and Genetics, Eggenstein-Leopoldshafen, Germany.



“Working with the LAS X Navigator is like sitting on the moon looking down at earth. Then you select your haunts – New York, Rio, Tokyo – and in the next moment you are there.”

Dr. Sandra Ritz, Institute of Molecular Biology GmbH, Mainz, Germany.



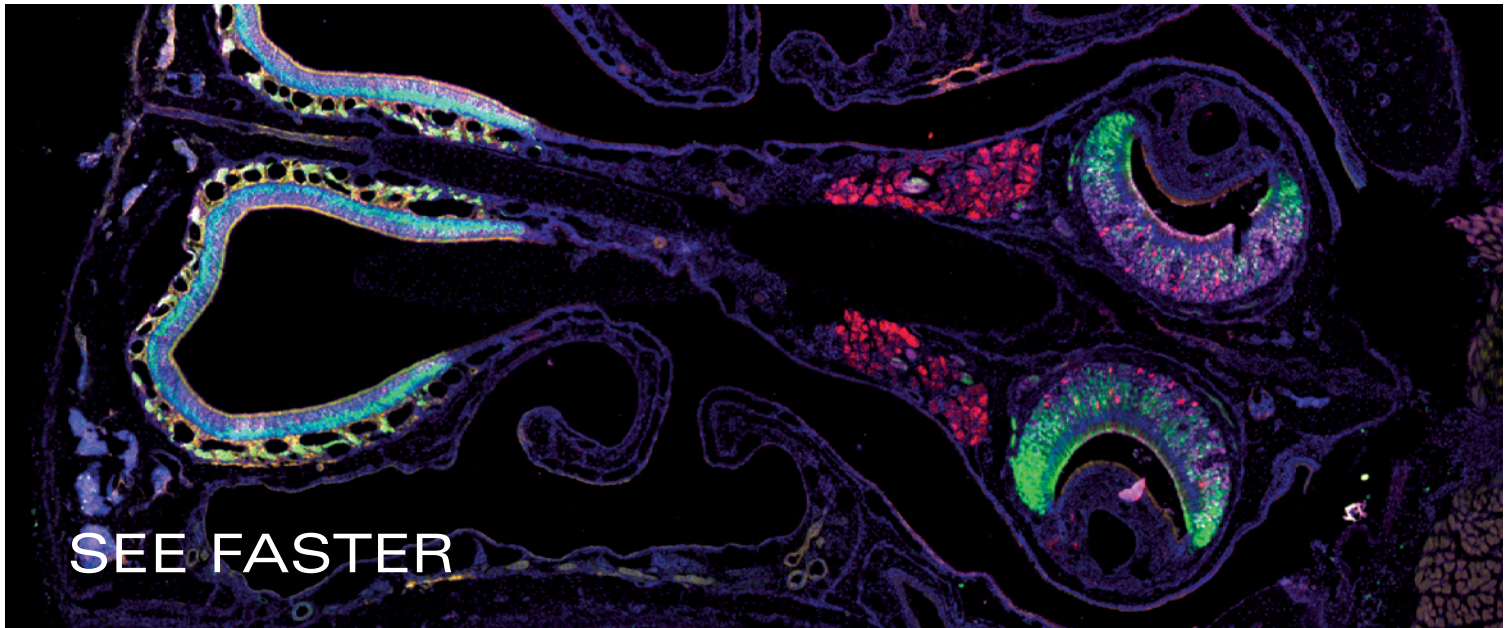

Three color immunostained coronal section of mouse nasal cavity.

DMi8 S POWERED BY LAS X SYNAPSE CAPTURE MORE DETAILS WITH UP TO 5X FASTER EXPERIMENTS

Find the missing links in your data faster

Utilize the LAS X Synapse advanced sequencer to follow events like vesicle trafficking and movement of kinesin motors along axonemes in simultaneous multi-color TIRF fluorescence at multiple stage positions over time. No matter which of the instrument components are part of the experiment, the system will run at the highest speed possible.

The DMi8 S imaging solution with LAS X Synapse software eliminates the bottlenecks between system components, resulting in dramatically faster imaging. With an integrated real-time controller that directly interacts with all of your hardware components, cameras and peripherals, you can control your entire system with micro-second precision. Time lapse experiments up to 5x faster mean you can both save time and capture more details.

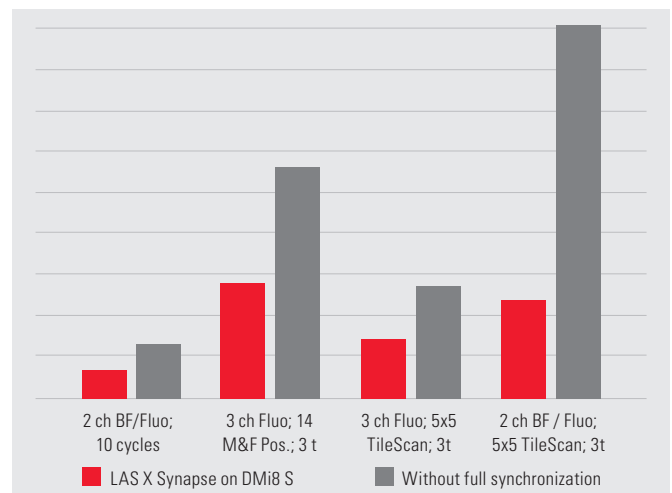

Faster imaging with DMi8 S. Comparison of total time for standard experiments before and after LAS X Synapse control.

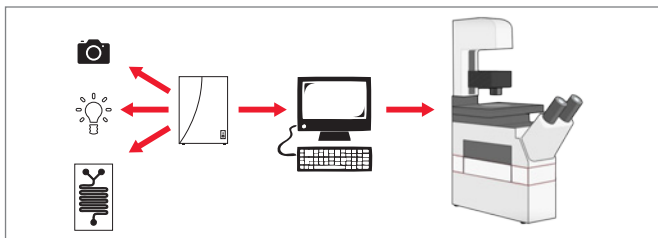

Fig. 1: Slow and convoluted connections between the system components limit the system's overall acquisition speed.

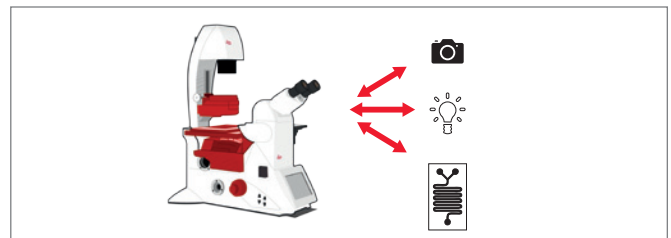
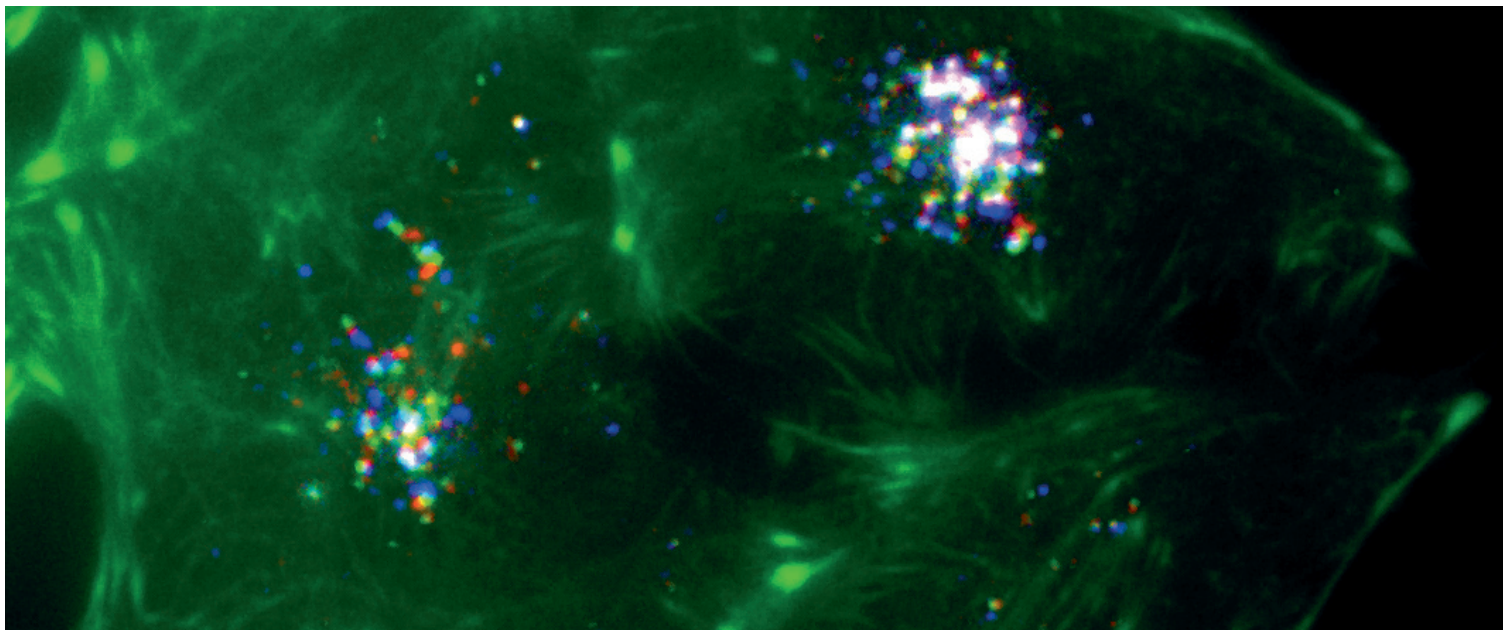
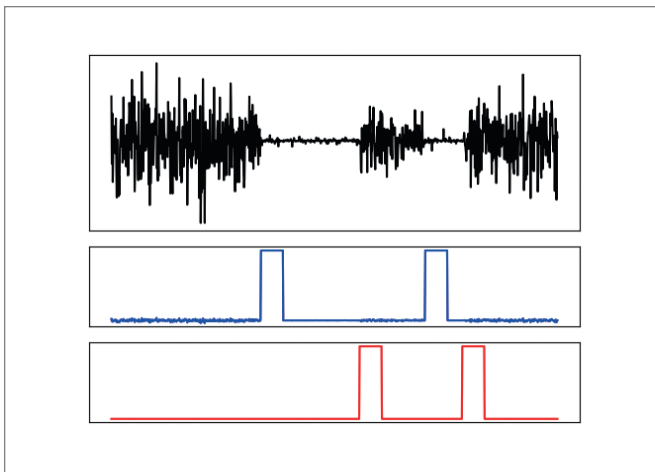

Fig. 2: The DMi8 S with LAS X Synapse allows you to achieve the highest acquisition speed possible by processing data more efficiently.



HeLa cells stably expressing Actin Chromobody-TagGFP2 and SIR-Lysosome. Overlay of three separately colored timepoints collected using Hi-Lo illumination showing lysosomal movements. Chromobody-TagGFP2 imaged using TIRF. Courtesy of ChromoTek GmbH, Munich, Germany, and Spirochrome SA.



Precisely synchronize your functional imaging to external stimuli. External sensor data (black) used to control imaging by sending stimuli triggers (red) and receiving imaging triggers (blue).

Full synchronization – Control any motorized component in the system without software jitter

Microsecond controller – Reach the highest speed through control of all parameters in real-time

Addition of peripherals – Control and sequence peripheral devices like light sources, microfluidics, and robotics with the full flexibility of LAS X

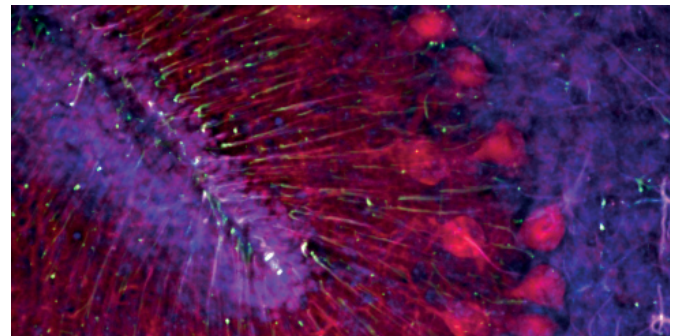

Use the DMi8 S with the advanced sequencer to set up dynamic experiments examining cellular responses.

Precise control

For specialized live cell applications, you can now add additional devices to the system and set up fully LAS X controlled experiments with precise timing and control of third party devices. With the ability to freely specify the behavior of the connections, you can create imaging sequences to analyze an organism's response to external stimuli delivered via third party devices. Define both digital and analog signals, and set up the trigger signaling independently from the image acquisition with exact timings and full reproducibility.

You can freely specify the behavior of the connections, by defining analog and digital signals. Then, set up the trigger signaling to send signal to and from devices independently from the image acquisition, allowing you to flexibly control the parameters of your experiment.

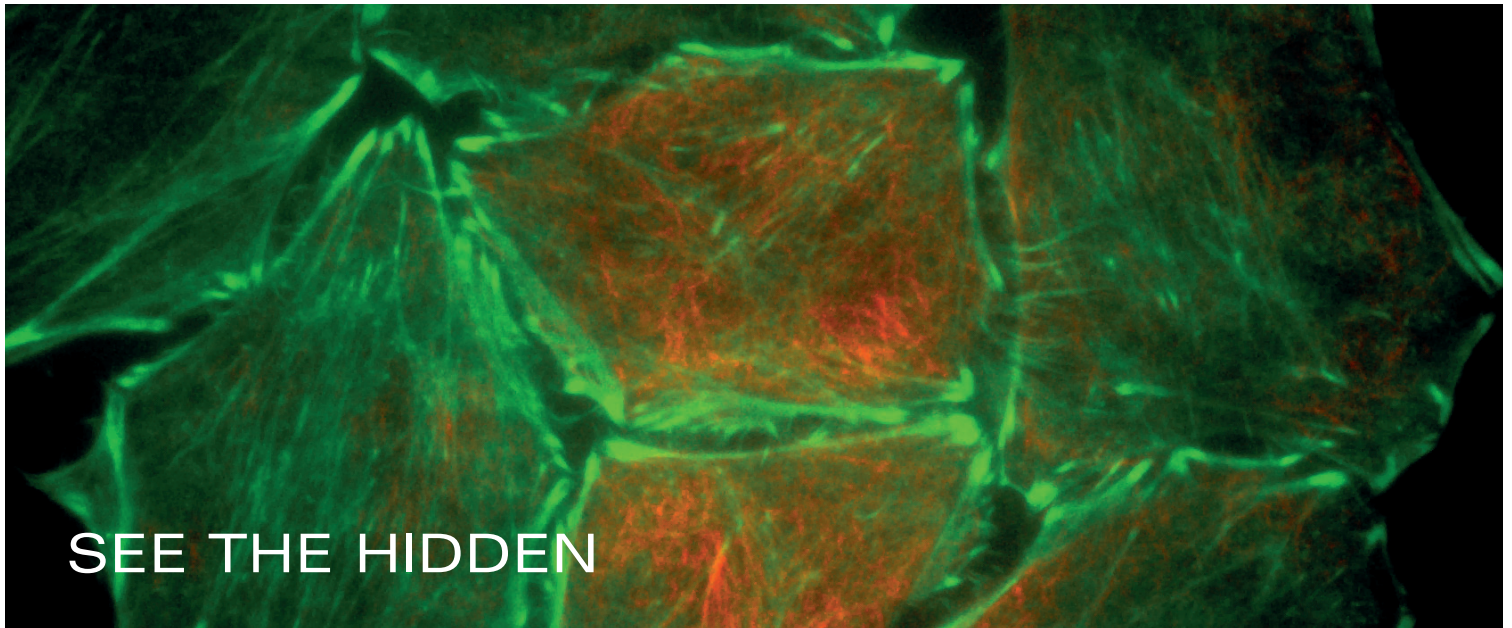

HeLa cells stably expressing Actin Chromobody-TagGFP2 and stained with SIR-Tubulin. Courtesy of ChromoTek GmbH, Munich, Germany, and Spirochrome SA.

DMi8 S INFINITY TIRF

SIMULTANEOUS MULTI-COLOR TIRF & SUPER-RESOLUTION MODULE

Reveal the missing links in your cells

Observe samples with outstanding clarity, control, and confidence with the DMi8 S Infinity TIRF module. For dynamic processes at the cell surface, TIRF (Total Internal Reflection Fluorescence) microscopy is the method of choice to visualize single molecules with super-resolution by maximizing the fluorescent signal-to-noise ratio. The Infinity TIRF module delivers versatile application possibilities with simultaneous multi-color EPI, Hi-Lo and TIRF illumination capability, as well as a high power illumination option for super-resolution applications.

Super-resolution

Supercharge your system with super-resolution and nanoscopy capabilities. Choose the Infinity TIRF High Power (HP) system to give you the ability to achieve multi-color single molecule resolution at the cell surface to resolve structures involved in receptor trafficking, synaptic organization, or cell adhesion. With the high-powered lasers option, you can image and analyze down to 20nm resolution with techniques such as single molecule particle tracking, GSD, dSTORM and uPaint.

Infinite possibilities

The DMi8 S solution is built with flexibility in mind. The Infinity TIRF module adds another Infinity Port to the system, allowing you to put up to three devices on the system at once. The unique optical design optimizes your ability to customize the system to your needs, without compromising the quality of your data.

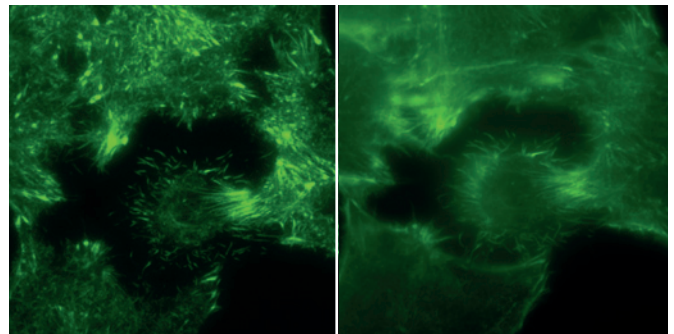

TIRF versus widefield: HeLa cells stably expressing Actin Chromobody-TagGFP2. Courtesy of ChromoTek GmbH, Munich, Germany.

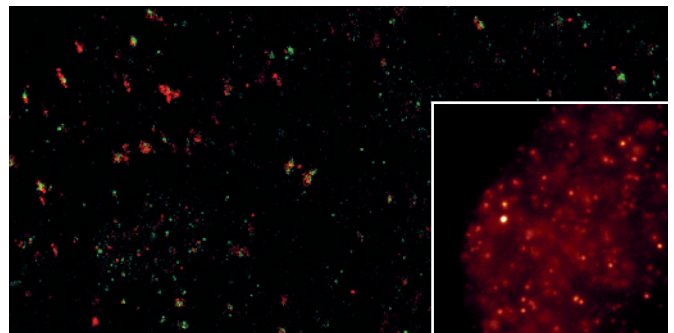

Comparison of 2 color widefield (inset) versus STORM imaging of radiation induced foci showing colocalization of two DNA damage repair proteins. Courtesy of Dr. Kalina Haas, Hutchison MRC Research Centre, University of Cambridge, UK.

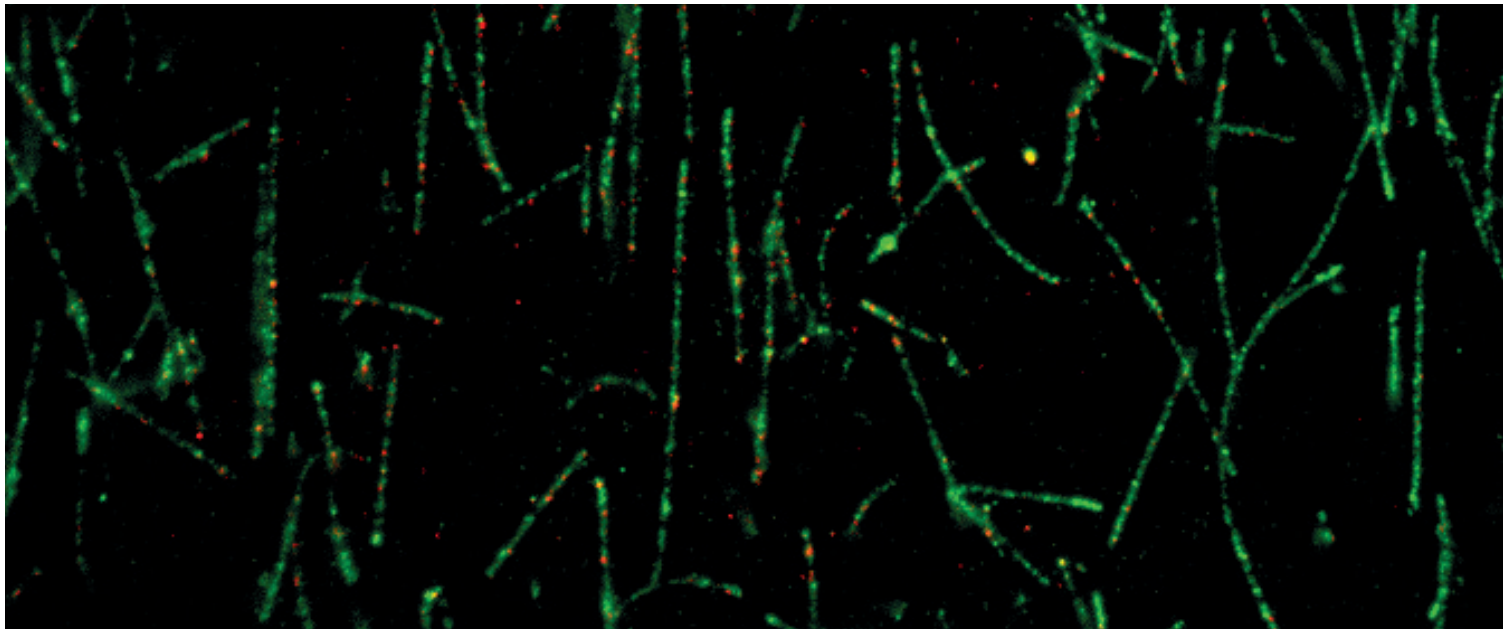

In vitro tracking experiment of Kinesin-2 from *c.elegans* at saturating ATP concentration. 11 subunit labeled with Snap-Alexa 488, 20 subunit labeled with Halo-660. Courtesy of Willi Stepp, Technical University of Munich, Germany.

Usability and reproducibility

Take the mystery out of setting up a TIRF experiment with the fully automated Infinity TIRF. Sample-specific alignment and calibration via integrated sensors ensure that your results are consistent and reproducible. Full integration with LAS X software helps you minimize setup and training time so that you can get to what really matters: your experiment. The Infinity TIRF can be customized with up to 5 lasers spanning from 405 to 640nm, so you can see the entire spectrum of fluorescence in your samples, with simultaneous multi-color imaging.

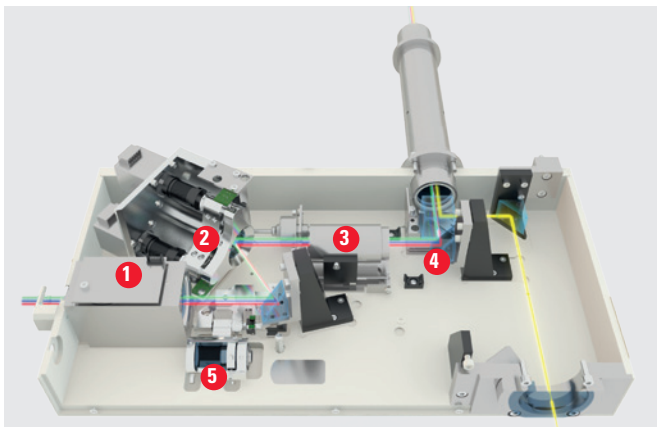

- 1 TIRF Sensor: Detects the back reflected beam and enabling reproducible automated adjustment of TIRF penetration depth in every sample
- 2 TIRF Scanner: Fine-tuning of TIRF penetration depth and adjustment of illumination direction (azimuth)
- 3 Movable collimator: Allows TIRF over full z-travel range with all Leica TIRF objectives
- 4 Merge Optics: Combines a second illumination light path through Infinity TIRF module
- 5 Beam Expander: Infinity TIRF HP module increases the power density on the sample for super-resolution imaging

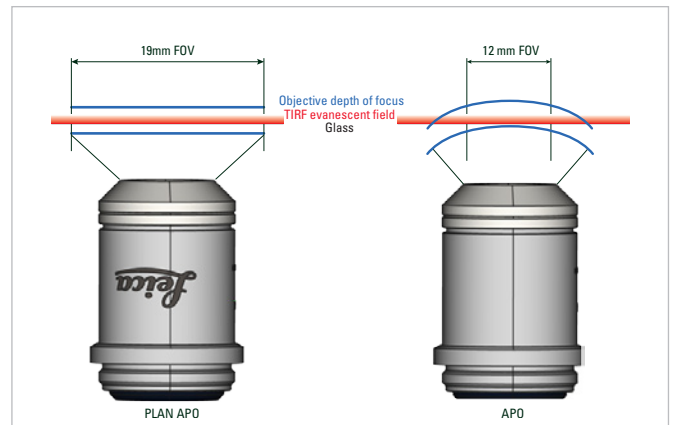

Dedicated TIRF objectives – Leica’s high quality PLAN APO corrected TIRF objectives enable a homogenous TIRF imaging over a full 19mm field of view (FOV).

High image quality starts with brilliant optics. With Plan APO corrected TIRF objectives and Field Number 19, you can see the smallest details of your sample, even at the edges of the field. The Infinity TIRF module connects to the DMi8 S imaging solution directly via the Infinity Ports, a perfect match for advanced imaging with sCMOS cameras.

The flexibility of the DMi8 S system extends even further, allowing multiple imaging modalities in one system. The Infinity TIRF module can be combined with the SP8 confocal microscope or the Infinity Scanner module, available both for new systems and to upgrade your existing system.

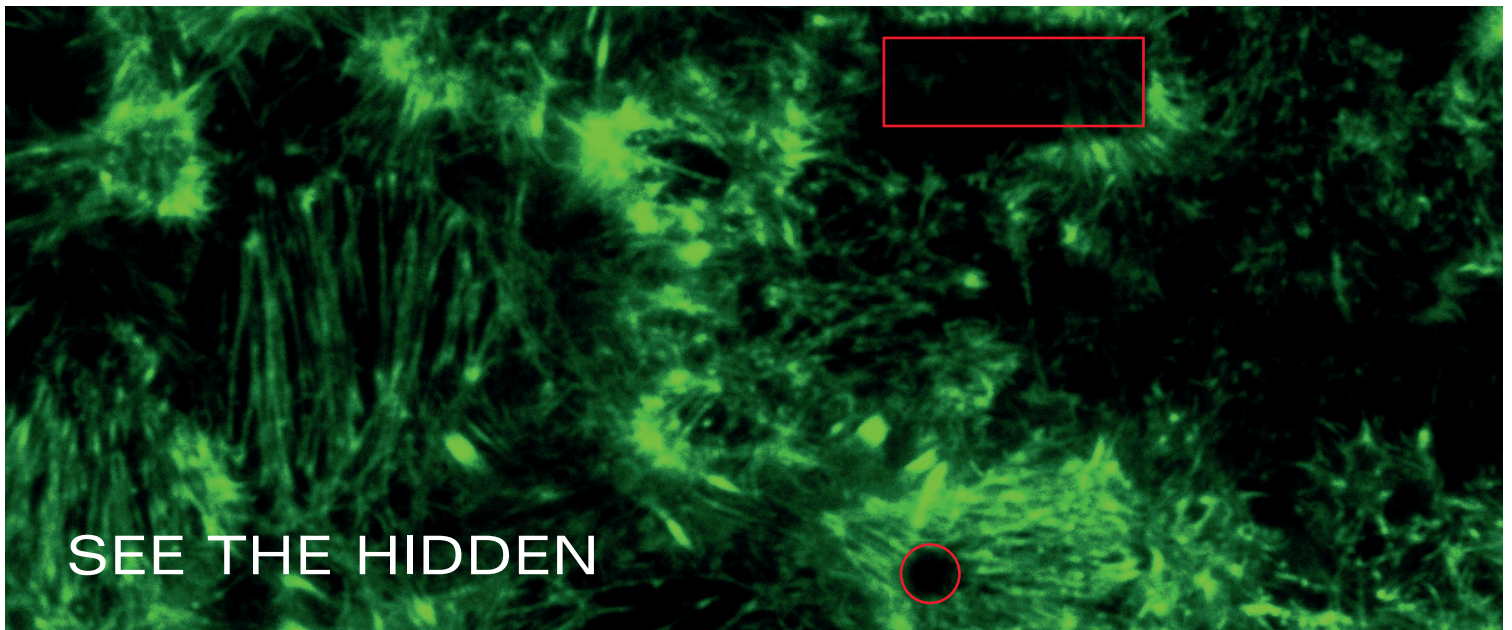

SEE THE HIDDEN

HeLa cells stably expressing Actin Chromobody-TagGFP2. Courtesy of ChromoTek GmbH, Munich, Germany.

DMi8 S INFINITY SCANNER

ACTIVATE, ABLATE, AND BLEACH IN ONE EXPERIMENT

Unmask the links hiding within your cells

Whether you need to bleach, cut, activate, stimulate or even combine multiple techniques, the Infinity Scanner can be configured to address your needs. The Infinity Scanner modules offer the ultimate multi-spectral photo manipulation tool designed to deliver unparalleled application flexibility. High speed vector scanning capabilities allow you to not only have precise control, but to take full advantage of the camera-based widefield system of the DMi8 S to capture the fastest cellular processes.

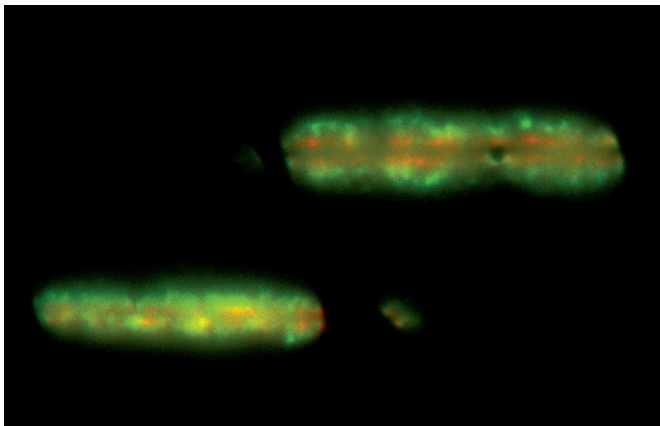

U2OS cells stably expressing paGFP-H2B treated with Hoechst and photostimulated with 405nm laser. Overlay of two timepoints showing propagation of chromatin decondensation upon DNA damage from a single horizontal line. Courtesy of Dr. Rebecca Smith, Physiological Chemistry, Biomedical Center, Ludwig-Maximilians-University, Martinsried, Germany.

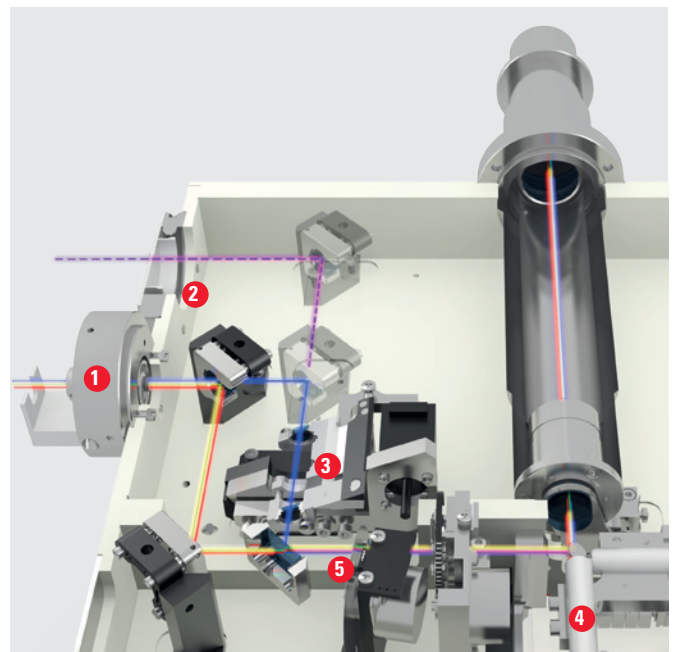

- 1 Fiber Port: Coupling of laser fiber from Widefield Supply Unit, stand-alone lasers or 3rd party lasers
- 2 Free Space Port: Fiber free direct laser coupling
- 3 Vario-Optic: Corrects 350 – 800nm wavelength lasers for parfocal scanning
- 4 Galvo scanners: High speed X-Y scanning of laser beam
- 5 Aperture: Adjustment of the scanner laser beam profile

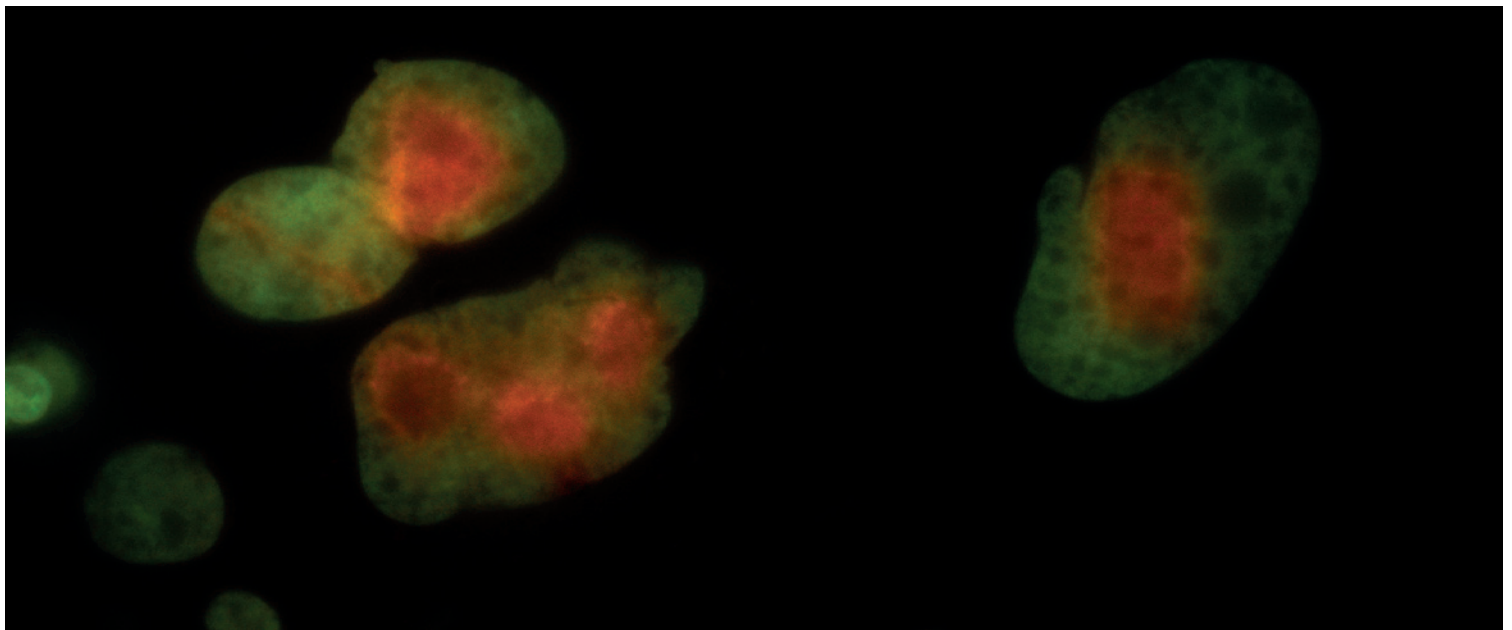

Dendra2-H2B photoswitching. Courtesy of Dr. Rebecca Smith, Physiological Chemistry, Biomedical Center, Ludwig-Maximilians-University, Martinsried, Germany.

LAS X Software integration

The Infinity Scanner is fully integrated into the LAS X software, so planning and executing even complex experiments is simple. Using the LAS X interface, set up multiple laser powers and channels for techniques like FRAP, FLIP, acceptor bleaching, activation, switching, optogenetics, DNA damage, cutting, ablation, or uncaging within a single experiment.

Tunable Photomanipulation

With dual optical pathways, the Infinity Scanner module is able to chromatically correct a wide range of lasers for multi-spectral photomanipulation applications using any objective. Add to that an adjustable beam profile for flexible execution of experiments, and the Infinity Scanner delivers unparalleled application flexibility.

Advanced experiment design

Use the new experiment design tool to set up and execute advanced experiments combining multiple imaging modalities. The modular design allows you to perform imaging tasks, like photomanipulation or TIRF, both simultaneously and sequentially. Quickly master setting up simple to complex time lapse experiments, z-stacks, and acquisition loops with this expandable tool.

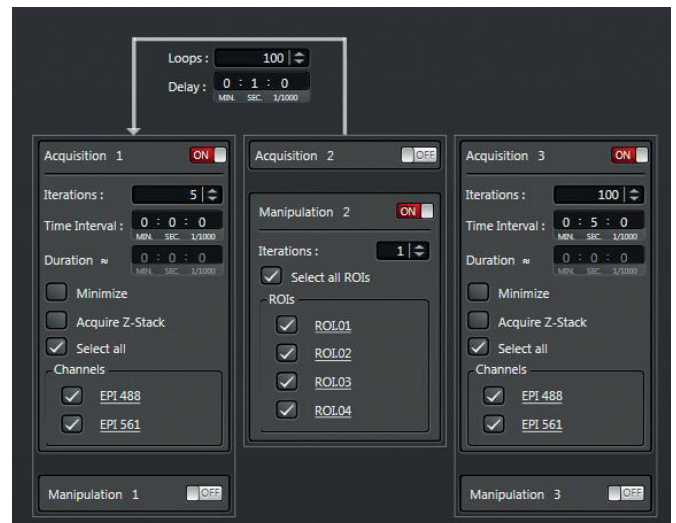

Add and configure experiments using the flexible experiment design tool in LAS X software.

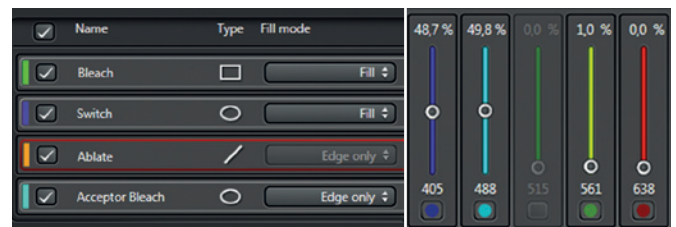

Define multiple photomanipulation tasks and laser powers in a single experiment.

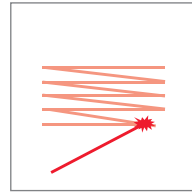
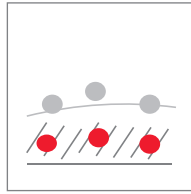

Applications

	Infinity TIRF	Infinity Scanner	DMi8 S powered by LAS X Synapse	LAS X Navigator
Live Cell Imaging	●	●	●	●
Membrane Physiology	●	●	●	●
Localization Microscopy	●		●	●
Combination with SP8 Confocal	●		●	●
Kinetic Studies	●	●	●	●
Photomanipulation		●	●	●
Molecular Dynamics	●	●	●	●
Nanoscopy/Super-Resolution	●		●	●



Tailor-made service solutions

When you buy equipment from Leica Microsystems, we deliver far more than a technological assembly of beautifully crafted components. Our goal is to deliver tailor-made service solutions to ensure optimal results, peace of mind, success, and pride. With ServiceCare, Leica Microsystems offers a range of service and support programs that are matched to a spectrum of requirements, systems, and budgets.

CONNECT
WITH US!

Leica Microsystems CMS GmbH | Ernst-Leitz-Strasse 17–37 | D-35578 Wetzlar (Germany)
Tel. +49 (0) 6441 29-0 | F +49 (0) 6441 29-2599

www.leica-microsystems.com/dmi8

